

# Hardware Reference Manual

Version 1.12

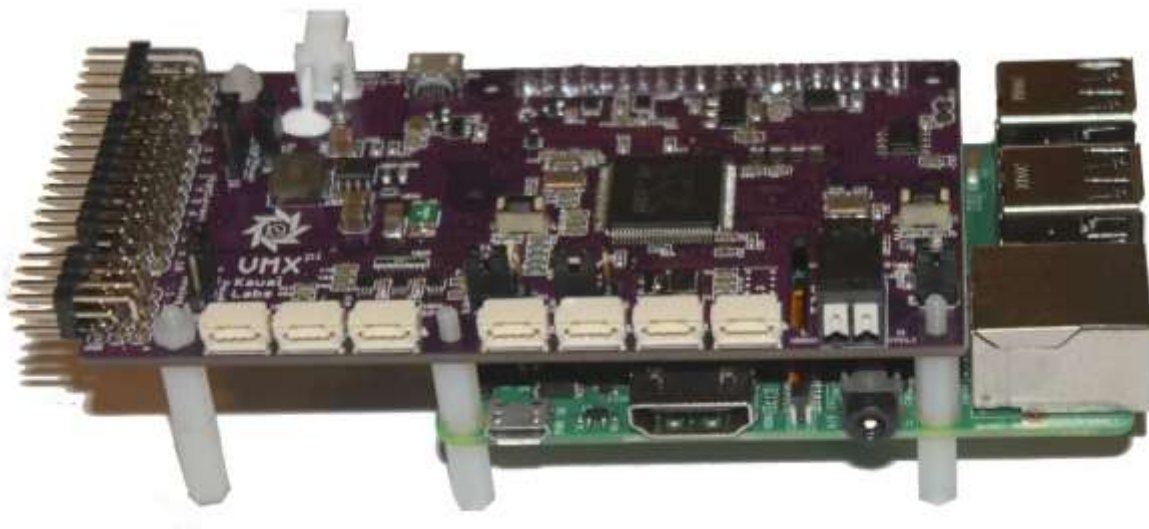

*Figure 1 VMX-pi configured with Raspberry Pi 3*

## Contents

- Feature Summary..... 3
- Technical Specifications ..... 5
- I/O Summary ..... 8
- I/O Resource Summary ..... 10
  - Channel/Resource Routing ..... 10
- I/O Channel Types/Numbers ..... 11
  - High Current DIO Input/Output Selection Jumper ..... 12
- Power Management Scheme..... 13
  - VMX-pi Power Management..... 14
- External Device Power/Signal Voltage Configuration..... 16
  - Signal Voltage Select Jumpers..... 16
  - Power Voltage Select Jumpers..... 16
- VMX-pi I/O Signal/Logic Levels ..... 16
- Board-edge Connectors ..... 18
  - FlexDIO Connectors (VMX Channels 0-7)..... 18
  - FlexDIO Header (VMX Channels 8-11) ..... 19
  - High-Current DIO Header (VMX Channels 12-21)..... 19
  - Analog Input Header (VMX Channels 22-25) ..... 20
  - CommDIO Connectors (VMX Channels 26-33) ..... 21
  - CAN Connector..... 21
  - CAN Termination Jumper..... 21
  - Micro-USB Connector ..... 22
  - Input Power Connector..... 22
- Battery & Real-time Clock..... 22
- 40-pin Raspberry Pi Connector ..... 23
- Optional 5V Fan Connector..... 23
- LEDs..... 23
- Buttons..... 24
- Physical Dimensions..... 25



### Feature Summary

VMX-pi is designed to control a reliable, intelligent robot that is tele-operated, semi-autonomous or fully-autonomous – when combined with an inexpensive Raspberry Pi-based processor. VMX-pi is also usable as a Vision/Motion co-processor when paired with another robot controller.

The current recommended Raspberry Pi model is the “Raspberry Pi 4B” or the “Raspberry Pi 3B+” (shown in picture on the cover page of this document); the Raspberry Pi Zero W may also be used although it provides only a subset of the Raspberry Pi 4B and 3B+ capabilities.

### VMX-pi + Raspberry Pi 4 Key Components

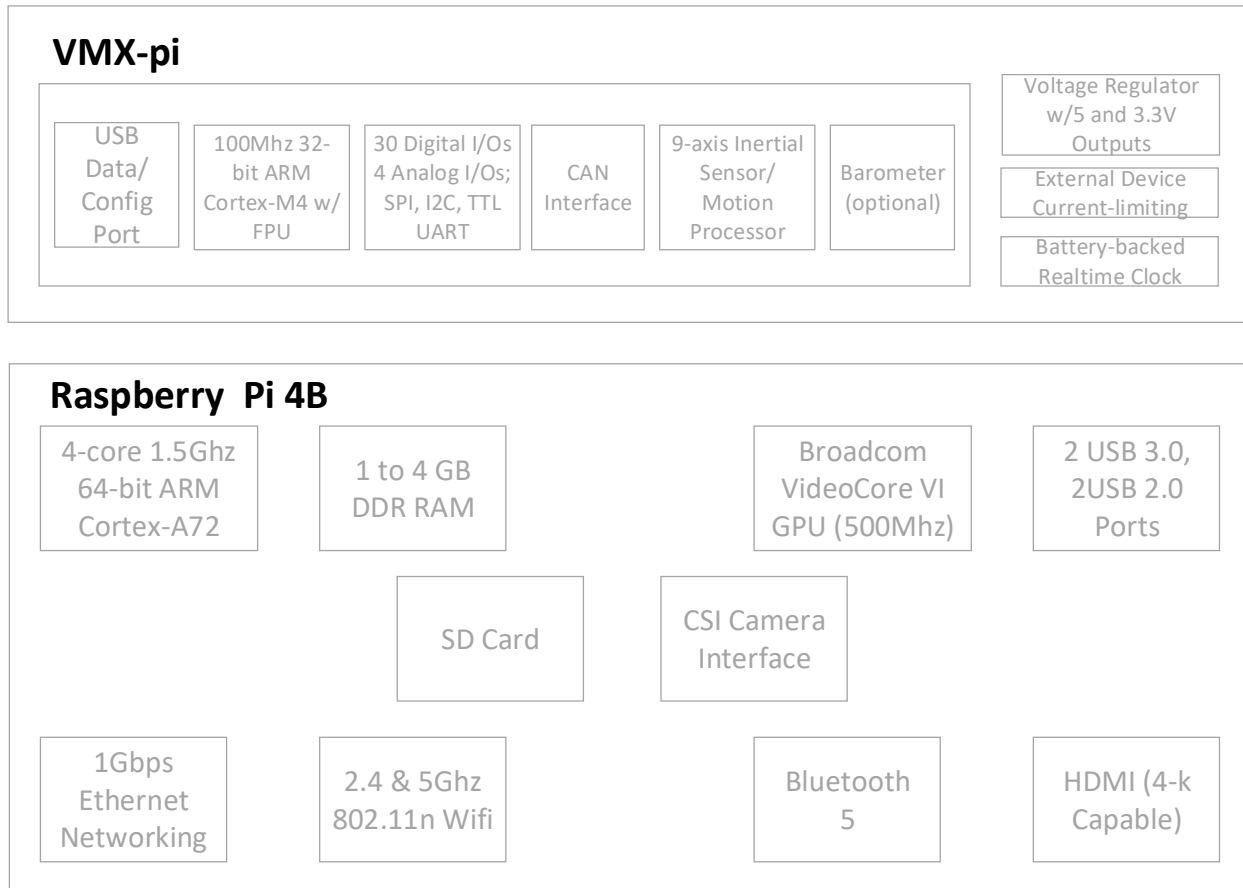

Figure 2 VMX-pi & Raspberry Pi Key Components

Component	Function	Key Attributes
Voltage Regulator w/wide input voltage range	Converts unregulated 6-16VDC to 5V & 3.3V, up to a maximum of 3A; includes real-time under-voltage management	Can provide 2.1A to Raspberry Pi and .5A to external devices at input voltages as low as 6VDC
External Device Current Limiting Switch & Short-circuit protection	External 5/3.3V supplies are current limited at .5A, to ensure full power is always provided to the Raspberry Pi processor and VMX-pi microcontroller	Processors continue running even when external devices draw excessive power or when short-circuits occur
5/3.3V Voltage Translation	Flexibly supports signaling with 5V and 3.3V external devices	Eliminates need for external voltage translation devices
Battery-backed Real-time Clock (RTC)	When VMX-pi is used in environments without Network Time Server access, provides real-time clock for distributed sensor data alignment and accurate log timestamps	Can be populated with a CR2032 battery w/expected life of 5 years before replacement
100Mhz 32-bit ARM-M4 w/FPU Microcontroller (STM32F411)	Implements real-time IO and timer functions, IMU sensor data fusion, CAN bus message buffering and Power/Brownout Management	Field-upgradable firmware can be updated w/new features and bugfixes
30 Digital I/Os with overvoltage protection	Flexible digital IO support including PWM Generation on outputs, PWM Capture, Quad Encoder decode, Interrupt Generation on inputs	<ul style="list-style-type: none"> <li>• PWM Generation on all outputs</li> <li>• PWM Capture on "FlexIO" inputs</li> <li>• Interrupt Generation on all inputs</li> <li>• Quadrature Encoder decode on 5 pairs of "FlexIO" inputs</li> </ul>
4 Analog I/Os with overvoltage protection	12-bit ADC providing 46.5k samples/sec on each channel	Over-sampling and Averaging Engine; Analog Triggering supporting Interrupt generation on Analog Inputs
CAN Interface	CAN 2.0b transceiver and controller supporting message transmission/reception and filtering	1 mbps bus data rate supported
9-axis Inertial Sensor/Motion Processor	Generates Yaw/Pitch/Roll measures as well as Quaternions and raw gyro/accelerometer/magnetometer data; also includes automatic calibration software w/flash-based storage of calibration data	Invensense MPU-9250 and navX-Technology Kauai Labs firmware
I2C Support	2 Comm DIO Channels can be configured for I2C communication w/built-in pullup resistors	400Khz I2C communication supported
TTL UART Support	2 Comm DIO Channels can be configured for TTL UART communication	115.2 kbps UART communication supported



SPI Support	4 Comm DIO Channels can be configured for SPI communication	8Mhz SPI communication supported
Locking Connectors	Locking Power, FlexDIO and CAN connectors	Helps ensure electrical circuits are not affected by vibration
Micro-USB external interface	Additional dedicated USB interface on VMX-pi	Enables remote access to IMU data, and VMX-pi configuration/firmware update

Table 1 VMX-pi Component Functions & Attributes

### Technical Specifications

VMX-pi Technical Specifications are summarized in the table below. Note that certain specifications may be improved over time due to firmware updates. For the most up-to-date technical specifications, please see the “Technical Specifications” page at <http://vmx-pi.kauailabs.com>.

ELECTRICAL SPECIFICATIONS	
Input Voltage:	6-16V DC
Output Voltages:	5V, 3.3V for External Devices 5V for Raspberry Pi
Protection Features:	Input Power Under-voltage Management Output Power Current Limiting/Short-circuit Protection Input Signal Over-voltage Protection
Communications Interface:	USB, I2C, SPI, CAN, UART
Power Connector:	2-Pin JST VH Connector
USB Connector:	USB Micro-B (can provide standalone power to VMX-pi microcontroller)
IMU PERFORMANCE SPECIFICATIONS	

Note: Certain IMU performance specifications are only valid after a start-up gyroscope/accelerometer calibration period, during which time the VMX-pi circuit board must be held still.



Startup Calibration Period:	15 seconds
Gyro Sensitivity:	+/- 2000 degrees/sec
Accel Sensitivity:	+/- 2 g
Magnetometer Sensitivity:	1.3 Gauss
Yaw angle accuracy:	~1 degree of drift/minute
Yaw angle accuracy (when still):	~.25 degree of drift/minute
Orientation Data Update Rate:	4-100 Hz
Magnetometer Raw Update Rate:	4 Hz
Magnetometer Angular Accuracy:	+/- 2 degrees
Pitch/Roll Angular Accuracy:	+/- 1.5 degrees

#### ANALOG INPUT SPECIFICATIONS

Number of Channels:	4
Resolution:	12 bits
Per-channel Sampling Rate:	46.5K samples/sec

#### DIGITAL IO SPECIFICATIONS

Total Number of Channels:	30
Number of Input-capable & Interrupt-capable Channels:	26
Number of Output-capable & PWM-capable Channels:	28



**Kauai Labs**  
Build Better Robots®

---

Number of Quadrature Encoder Channel Pairs (Hardware-decode):	5
--	---

---

Number of PWM Capture Inputs	6
------------------------------	---

---

<b>DIGITAL COMMUNICATION SPECIFICATIONS</b>	
---	--

---

CAN Protocol (2.0b)	1mbps (also supports 500kbps and 250kbps)
---------------------	---

---

SPI Protocol	8 Mhz
--------------	-------

---

I2C Protocol	400 kHz
--------------	---------

---

USB Protocol	v. 3.0 (5 Gbps)
--------------	-----------------

---

UART Protocol	115,200 bps
---------------	-------------

---



**Kauai Labs**  
*Build Better Robots®*

I/O Summary

VMX-pi I/O Summary

- 30 Digital I/O Channels
  - 12 “FlexDIOS”; PWM-capable, H/W decode of 5 Quadrature Encoders
  - 10 “High Current DIOS”: either all inputs or all PWM-capable outputs
  - 8 “Comm DIOS” (6 PWM-capable outputs, 4 inputs) supporting SPI, I2C and UART or Digital I/O functions
- 4 Analog Input Channels
- Dedicated CAN Interface

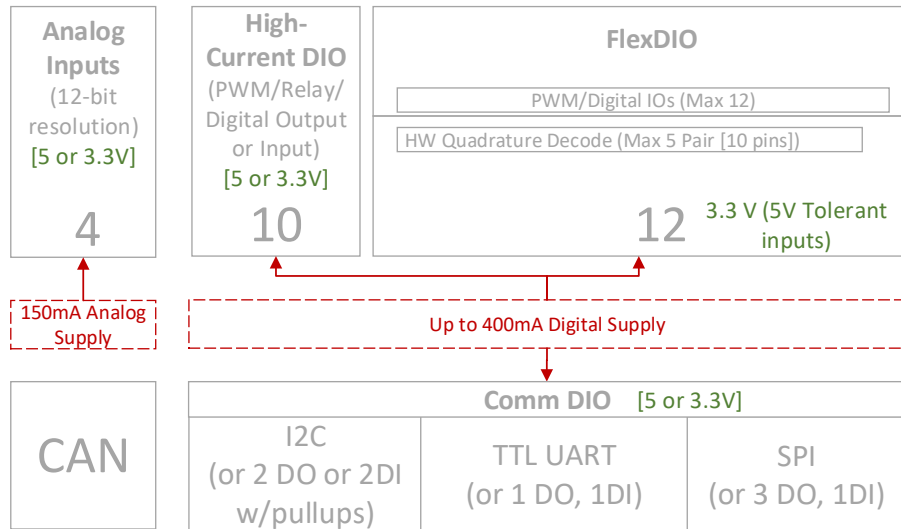

Figure 3 VMX-pi IO Summary

**FlexDIO Channels:** These channels drive 3.3V, are 5V tolerant when used as inputs, and each channel is individually software configurable as input or output channel. FlexDIO channels have a lower output current drive than other channel types, and support advanced timer functions including decoding of signals from quadrature encoders.

**High-Current DIO Channels:** These channels drive 3.3V or 5V (jumper-configurable), and are jumper-configurable to be either all inputs or all outputs. High-Current DIO channels provided enhanced current-drive capabilities allowing them to be used to drive relays as well as motor controllers.

**Analog Input Channels:** These channels accept 3.3V or 5V input signals.

**Comm DIO Channels:** These channels drive 3.3V or 5V (jumper-configurable); some are fixed as input channels, and some are as fixed output channels. These channels support a medium-current drive capability to support communication across extended distances, subject to the restrictions of each protocol; these channels are designed to support high-bandwidth communication rates.



CAN Interface: The CAN interface supports a positive and negative differential signal pair. NOTE: The two CAN signals are not referred to as “I/O Channels” and are not referenced by “VMX-pi Channel Numbers” below.

Table 2 VMX I/O Channel Type Summary

Type	Count	S/W Direction Select	High Current/Jumper Direction Select	Analog Input	Digital Comm
FlexDIO	12	Yes			
HiCurrDIO	10		Yes		
CommDIO	8				Yes
AnalogIn	4			Yes	



### I/O Resource Summary

Each VMX-pi channel can be used for multiple functions. This flexibility functionality is provided by a set of **I/O Resources**. Each VMX-pi channel may be routed (under software control) to different I/O resources, depending upon the VMX-pi application requirements.

Type	Description	Typical Use
Digital Input	Detects current signal digital level (high/low)	Reading state of a button
Digital Output	Transmits current signal digital level (high/low)	Triggering a Relay
PWM Generator	Transmits periodic pulses with configurable period and pulse-width	Controlling a motor or servo
PWM Capture	Measures pulse with (frequency and duty cycle) of periodic pulses	Reading current pulse width from servo controller
Interrupt	Generates Interrupts on selected signal edge transitions	Counting “ticks” of an ultrasonic distance sensor
Accumulator	Performs Oversampling/Averaging on an Analog Input	Noise-removal and resolution enhancement on inputs from an analog potentiometer
Analog Trigger	Generates Interrupts on analog input high/low level transitions	Counting “ticks” of an analog sensor input
UART	TX/RX line data transceiver	Communication with an external GPS
SPI	CLK/MOSI/MISO/CS line data transceiver	Communication with an external IMU sensor
I2C	SCL/SDA line data transceiver	Communication with an external LIDAR sensor

Table 3 VMX-pi Resource Summary

Many I/O Resource Types support a single I/O Channel; certain Resource Types may support more than 1 channel (e.g., a Quadrature Encoder Resource supports two I/O Channels, one for the A signal and another for the B signal).

### Channel/Resource Routing

To use an I/O Resource, one or more I/O Channels must be routed to the resource. Each I/O Channel Type may be routed to the following I/O Resources:

Type	DIO/ PWM	Encoder	PWM Capture	Interrupt	Accumulator	Analog Trigger	UART	SPI	I2C
# Chan per Resource	1	2	1	1	1	1	2	4	2
FlexDIO	Yes	Yes	Yes	Yes					
HiCurrDIO	Yes			Yes					



CommDIO	Yes			Yes		Yes	Yes	Yes
AnalogIn				Yes	Yes	Yes		

### I/O Channel Types/Numbers

VMX-pi follows a Channel-numbering scheme for all I/O connectors (except the signals on the CAN connector), allowing application software to address and reconfigure the functions on each channel. Note that all Channel Numbers start from 0, and begin with FlexDIO connectors on the bottom-right of the below diagram and increase in a counter-clockwise direction.

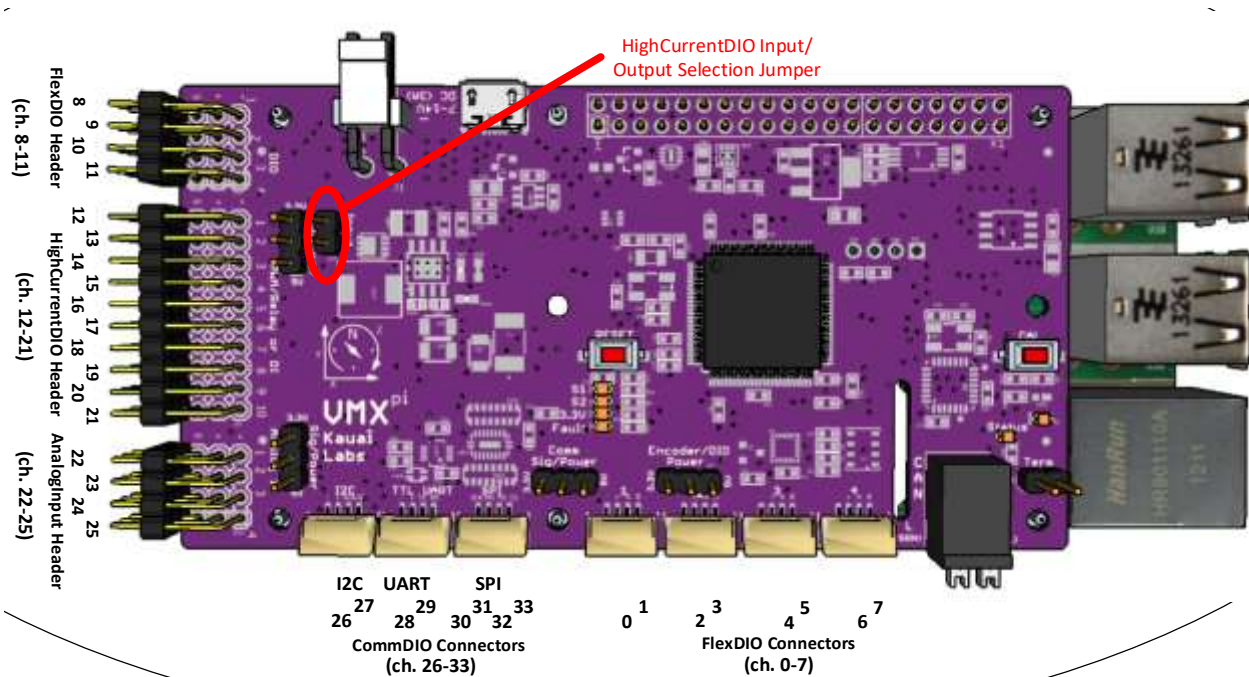

Figure 4 VMX-pi Channel Types and Numbers

I/O Channel Type	Connector Type	Channel Numbers	Location
Flex DIO Connectors	Connector	0-7	Bottom-right
Flex DIO Header	Header	8-11	Left-side Top
High Current DIO	Header	12-21	Left-side mid
Analog Input	Header	22-25	Left-side bottom
Comm DIO	Connector	26-33	Bottom-left

### High Current DIO Input/Output Selection Jumper

The entire bank of High Current DIOs can be either all inputs, or all outputs. This selection is performed in hardware via the High Current DIO Input/Output Selection Jumper. If the jumper is present, all High Current DIOs function as outputs, otherwise they function as inputs.



**Kauai Labs**  
*Build Better Robots®*

### Power Management Scheme

To minimize the number of system components, VMX-pi provides integrated voltage regulators; the input power source may be a wide range of DC input voltages (e.g., from a battery) and outputs 5VDC to the Raspberry Pi, as well as 5VDC and 3.3V DC External Devices.

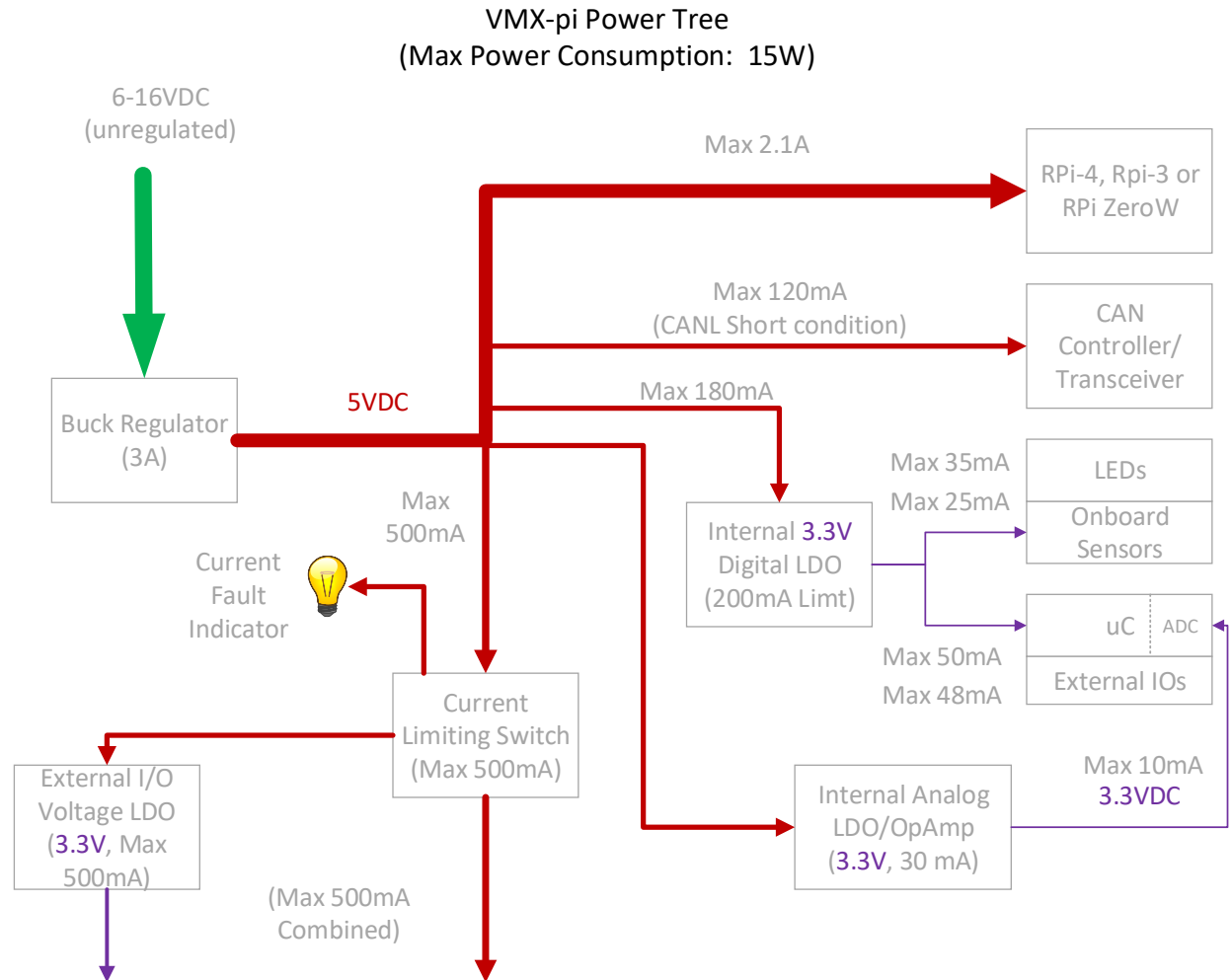

VMX-pi is powered by a single 6-16VDC unregulated voltage source, and the devices it powers may consume up to 3 Amps (15 Watts). The VMX-pi voltage regulators are designed to output the following maximum current levels:

Max. Current	Purpose
<b>2.1 Amps</b>	Raspberry Pi Processor & USB peripheral power
<b>.4 Amps</b>	VMX-pi microcontroller and onboard circuitry power (including IMU, CAN and signal-driving circuitry)
<b>.5 Amps</b>	VMX-pi External Device power

## VMX-pi Power Management

VMX-pi Power Management ensures reasonable system behavior in exceptional events including Input Power under-voltage, and also external device power over-current and short-circuit conditions.

### *External Device Over-current and short-circuit management*

When the VMX-pi 5V and 3.3V regulators that provide power to External Devices detect a current draw from those external devices exceeding the maximum current level (.5A), current is either limited to the maximum, or alternatively the current is completely removed, depending upon software configuration. This design ensures that sufficient power is reserved for proper operation of the VMX-pi microcontroller and the Raspberry Pi processor and its USB peripherals - even when External Device short-circuit conditions occur.

### *Input Power under-voltage management*

In Input Power under-voltage situations, VMX-pi is designed to preserve power to the VMX-pi microcontroller and the Raspberry Pi processor, at the expense of any peripherals which may be attached. Specifically, VMX-pi's power management scheme prioritizes the Raspberry PI power supply first, then the VMX-pi microcontroller second, and lowest priority is given to any External Devices. This design ensures that critical components are able to maintain state (e.g., software algorithms, IMU calibration coefficients, or buffers of recently received CAN packets).

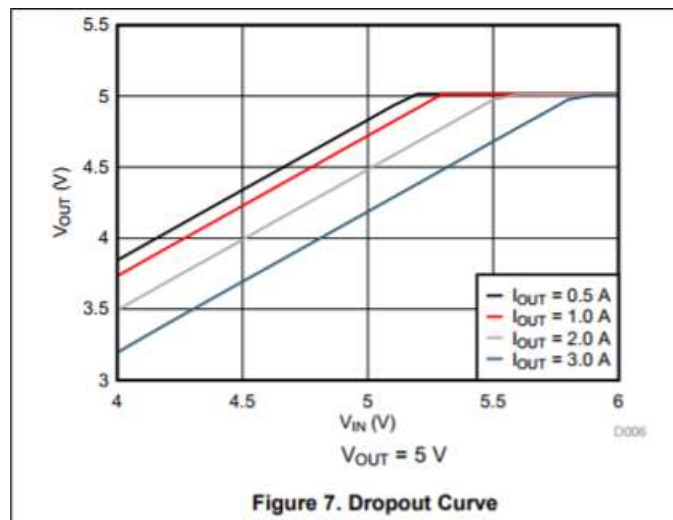

Figure 5 VMX-pi power supply voltage regulator dropout curve

As shown in the VMX-pi voltage regulator dropout curve above, the VMX-pi voltage regulator can guarantee the full 3A (15W) power output as long as the Input Power voltage is above 5.75V.

The Raspberry Pi 3 USB power supply – which is designed to power external USB devices - will brown out when the VMX-pi 5V voltage regulator output drops below 4.75V. At the maximum 3A load, this corresponds to a VMX-pi input voltage of 5.75V. For a more typical lightly-loaded Raspberry Pi consuming 1A, this corresponds to a minimum input voltage of 5V. Note also that the Raspberry Pi processor will continue to function until the VMX-pi input voltage reaches 4.5V, and the VMX-pi



**Kauai Labs**  
Build Better Robots®

microcontroller will continue to function until the VMX-pi input voltage reaches 4V – however these extremely low voltages are insufficient to support fully-operational scenarios, and can only main processor life-support. *Therefore, the minimum required voltage is 5.75V.*

To manage low Input Power voltage situations typically occurring in battery-operated scenarios, when VMX-pi detects Input Power voltage levels below 5.75V, the External Device power supply output (e.g., power supplied to power pins on FlexDIO, HighCurrentDIO, AnalogInput and CommDIO headers/connectors) is temporarily disabled until the input voltage rises again to approximately 5.85V. This ensures the full 3A output current remains available to the Raspberry Pi and the VMX-pi microcontroller.

The system behavior at various Input Power voltage levels is summarized below:

Input Power Voltage	VMX-pi external devices	Raspberry Pi external USB devices	Raspberry Pi Processor	VMX-pi Microcontroller
<b>5.75V and above (at full 3A load)</b>	OK	OK	OK	OK
<b>Below 5.75V</b>	External device Power rail disabled	OK	OK	OK
<b>Below 4.75V</b>	External device Power rail disabled	Insufficient Power	OK	OK
<b>Below 4.5V</b>	External device Power rail disabled	Insufficient Power	Insufficient Power	OK
<b>Below 4V</b>	External device Power rail disabled	Insufficient Power	Insufficient Power	Insufficient Power

## External Device Power/Signal Voltage Configuration

VMX-pi provides flexibility in the voltage used to power and exchange signals with External Devices. Several onboard jumpers allow various configurations to address many system configurations, typically eliminating the need for external voltage translation devices.

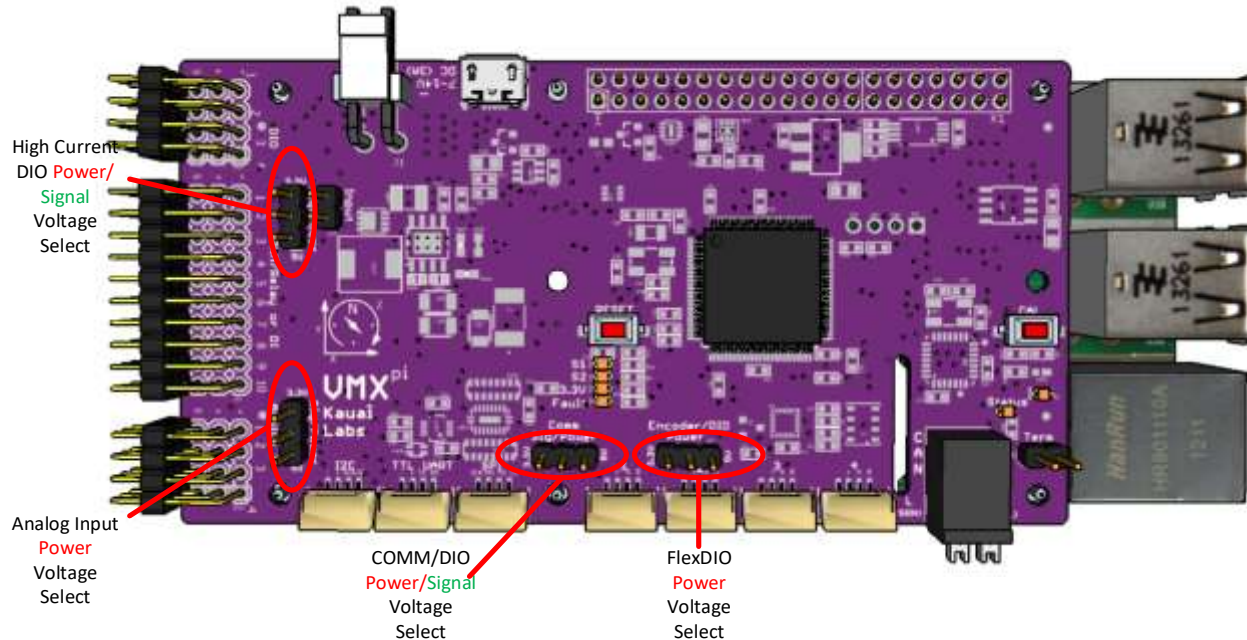

Figure 6 VMX-pi Signal/Power Voltage Select Jumpers

### Signal Voltage Select Jumpers

Either 5 or 3.3V output signal levels may be selected for High Current and Comm DIOs.

Note 1: Flex DIOs are fixed at 3.3V output levels.

Note 2: All inputs are tolerant of higher voltages, see Table 5 below.

### Power Voltage Select Jumpers

Either 5 or 3.3V power output for external devices may be selected for Flex, High Current and Comm DIOs and also for power pins on the Analog Input block

### VMX-pi I/O Signal/Logic Levels

VMX-pi Analog and Digital I/O channels are designed to support nominal signal levels in both 3.3V and 5V systems, and also include circuit protection circuitry to handle cases when input signal levels exceed the expected range.



Table 4 Digital Channel output signal drive current summary

Channel Type	Max. Drive Current
FlexDIO	4mA (@3.3V)
High-Current DIO	12mA (@5V)
CommDIO	10mA (@3.3V)
CAN	45mA

Table 5 Analog/Digital Input Channel signal over-voltage protection summary

Channel Type	Vmax(DC)
FlexDIO	12V
High-Current DIO	12V
Analog Inputs	12V (Vmin = -12V)
CommDIO	6V
CAN	58V

Table 6 Digital Channel signal Logic Level summary

Channel Type	Input/Output Logic Levels	Output V maxLow/minHigh
FlexDIO	3.3V TTL/CMOS	0.4V, 2.4V @4mA [3.3V]
High-Current DIO	3.3V/5V CMOS	0.24V, 4.75v @1mA [5V mode]
CommDIO	3.3V/5V CMOS	1.5V, 3.3V @4mA [5V mode] .8V, 2V @4mA [3.3V mode]

Table 7 Digital Channel Pull-up/Pull-down resistance summary

Channel Type	Pull Direction	Resistance
FlexDIO	Up, Down or Floating (s/w selectable)	50k-ohm
High-Current DIO	Pull-down	40k-ohm
CommDIO I2C (when used as input)	Pull-up	2.2k-ohm
CommDIO (UART when used as a digital input channel)	Floating	n/a
CommDIO SPI (when used as a digital input channel)	Floating	n/a

Note that CommDIO input signals are floating in support of high-bandwidth communications. In certain applications, external pull-up resistors may be used but are not typically required.



### Board-edge Connectors

VMX-pi connectors are oriented at right-angles to the circuit board. Many of the connectors use locking connectors to ensure reliable connectivity.

#### VMX-pi External IO Connector Summary (NOTE: All connectors exit at right-angle from board)

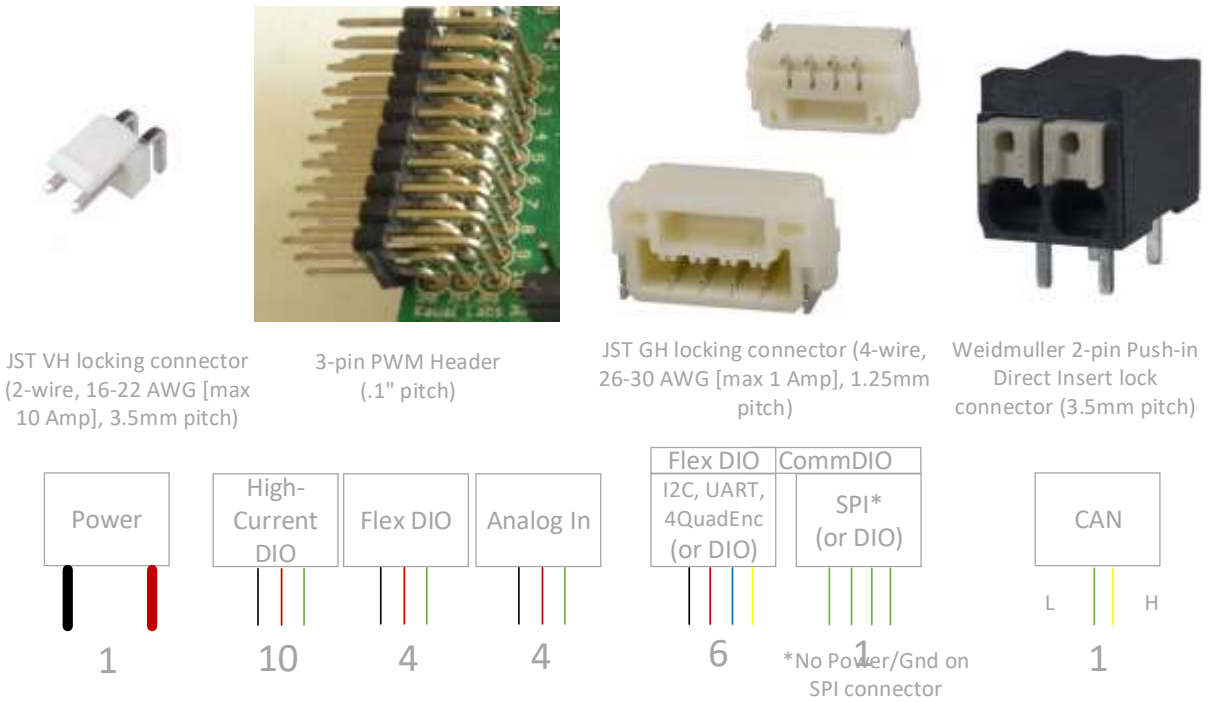

Note: Power cables and JSG GH cables and associated breakout boards are available at the Kauai Labs online store ([www.kauailabs.com/store](http://www.kauailabs.com/store)).

#### FlexDIO Connectors (VMX Channels 0-7)

FlexDIO Connectors are a set of four locking JST GH connectors (4 pins each) with power, ground, signal A and signal B on each connector. These connectors are designed to support Quadrature Encoders, but may also be configured for use as Digital Inputs, Interrupts, Digital Outputs, PWM Generation or PWM Capture.

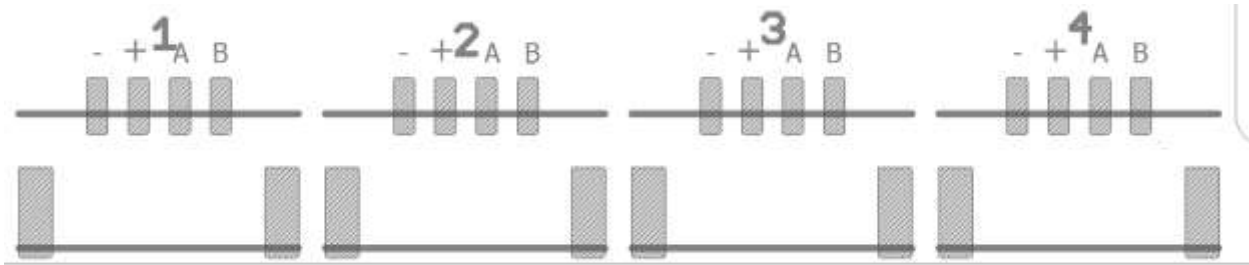

Figure 7 FlexDIO GH Connector (VMX Channels 0-7) pinout

### FlexDIO Header (VMX Channels 8-11)

The FlexDIO Header provides 4 sets of power, ground, and a single signal channel. The signals may be configured to support Quadrature Encoders, Digital Inputs, Interrupts, Digital Outputs, PWM Generation or PWM Capture.

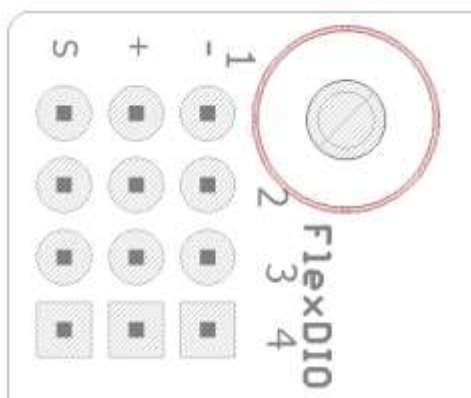

Figure 8 FlexDIO Header (VMX Channels 8-11) pinout

### High-Current DIO Header (VMX Channels 12-21)

The High-Current DIO Header provides 10 sets of power, ground, and a single signal channel. The signals may be configured to support Digital Inputs, Interrupts, Digital Outputs, or PWM Generation.

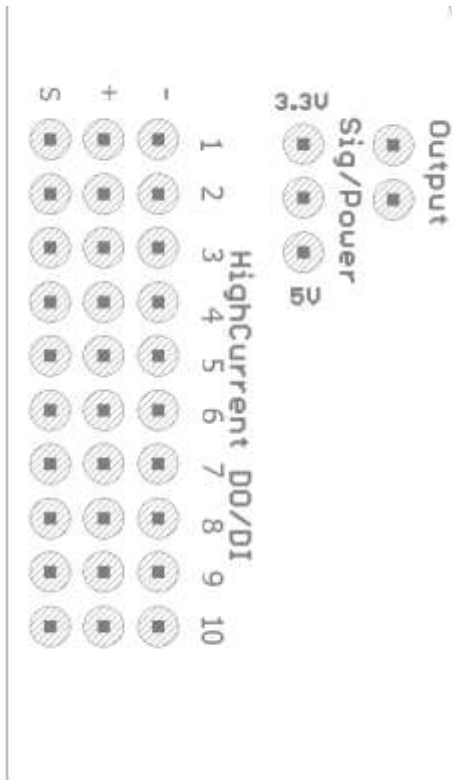

Figure 9 HighCurrentDIO Header (VMX Channels 12-21) pinout

### Analog Input Header (VMX Channels 22-25)

The Analog Input Header provides 4 sets of power, ground, and a single signal channel. The signals may be configured to support Analog Accumulation or Analog Interrupts.

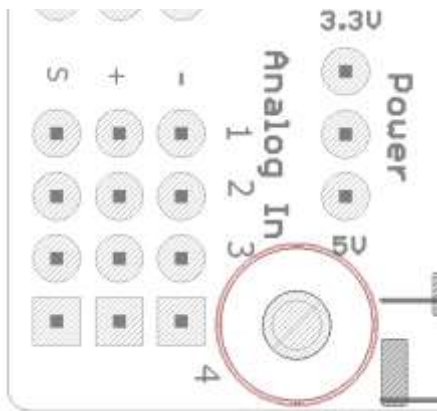

Figure 10 Analog Input Header (VMX Channels 22-25) pinout

### CommDIO Connectors (VMX Channels 26-33)

The 3 CommDIO Connectors are three locking JST GH connectors (4 pins each) with different sets of power/ground/signals. Each connector may be configured to communication using the corresponding digital communication protocol. Alternatively, the Input Channels may be configured for use as Digital Inputs or Interrupts; Output Channels may be configured for use as Digital Outputs or PWM.

	Pin 1	Pin 2	Pin 3	Pin 4
<b>I2C</b>	Ground	Power (5 or 3.3V)	SDA (Channel 26) [OUTPUT]	SCL (Channel 27) [OUTPUT]
<b>UART</b>	Ground	Power (5 or 3.3V)	TX (Channel 28) [OUTPUT]	RX (Channel 29) [INPUT]
<b>SPI</b>	SCK (Channel 30) [OUTPUT]	MOSI (Channel 31) [OUTPUT]	MISO (Channel 32) [INPUT]	CS (Channel 33) [OUTPUT]

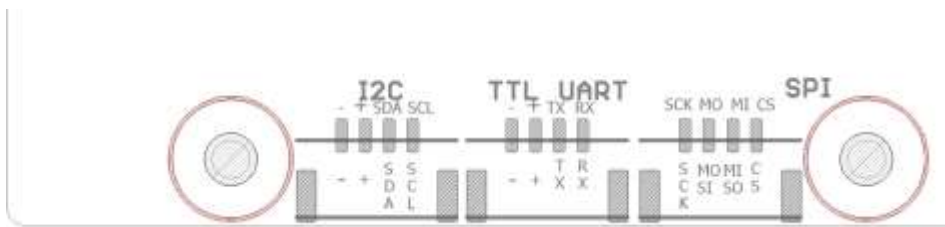
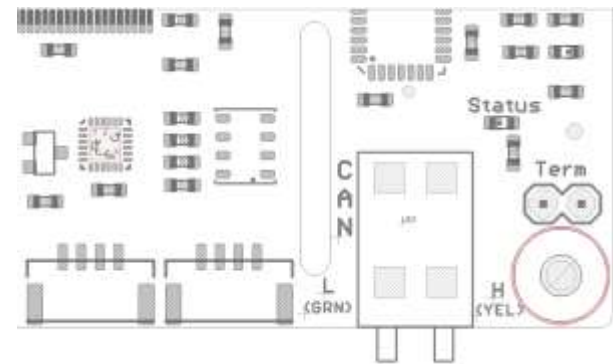

Figure 11 CommDIO Connector (VMX Channels 26-33) pinout

### CAN Connector

The CAN Connector is a 2-pin Weidmuller Push-in Direct Insert Lock Connectors designed to connect to the CAN Low (L) and CAN High (H) signals.



S

Figure 12 CAN Connector and CAN 10KOhm Termination Header

### CAN Termination Jumper

A CAN Termination Jumper is also provided; when a jumper is installed, a 10K-ohm resistor is enabled in order to provide CAN bus termination.

### Micro-USB Connector

A Micro-USB Connector is provided allowing for both remote configuration/management (including firmware upgrade) as well as access to a real-time data stream (up to 200Hz) from the onboard navX-technology IMU.

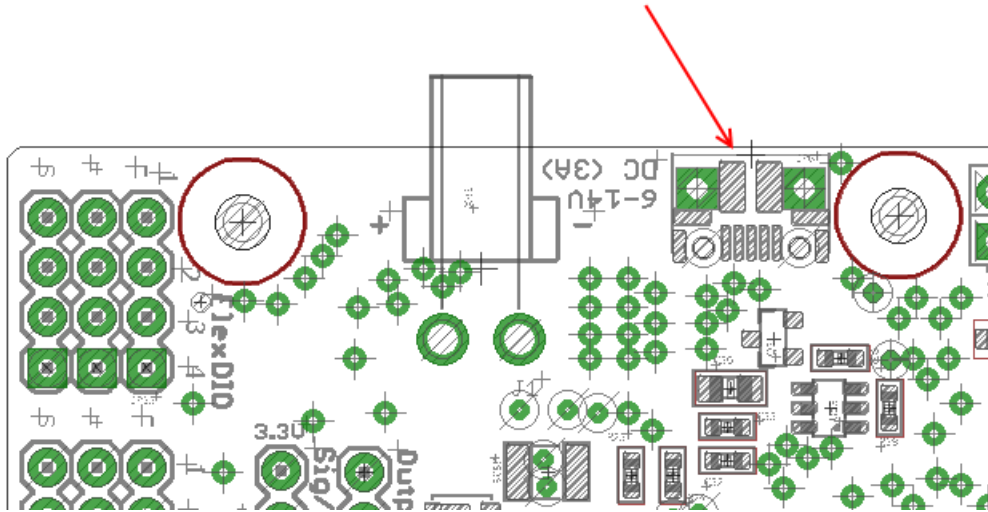

Figure 13 Micro-USB Connector

### Input Power Connector

A JST VH Locking Connector provides power to the circuit board, as well as the connected Raspberry Pi and any external devices. The connector is rated for 10A, which well exceeds the VMX-pi current limit of 3A.

### Battery & Real-time Clock

VMX-pi includes a pre-installed CR2032 3V Battery and associated Real-time Clock, enabling VMX-pi to manage a date/time clock (with 500 microsecond resolution) which can be used to timestamp logs, provide a network clock source in systems where an accurate time source is not present, and to synchronize sensor data from multiple sources.

The Battery is installed on the under-side of the circuit board, as shown in Figure 14.

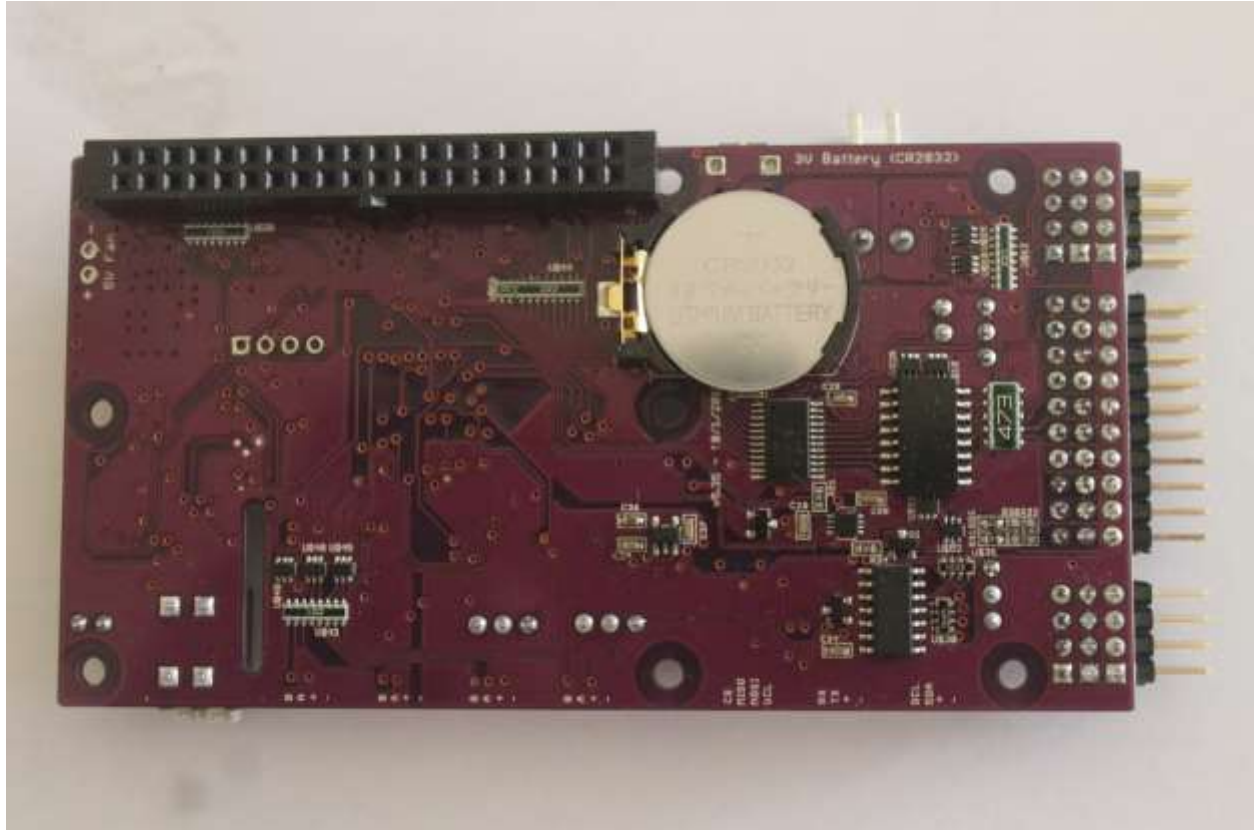

Figure 14 VMX-pi circuit board bottom-side

### 40-pin Raspberry Pi Connector

A 40-pin connector is mounted to the VMX-pi circuit board bottom-side, and is designed to connect to the GPIO connector on the Raspberry Pi 3 or the Raspberry Pi Zero W.

### Optional 5V Fan Connector

5VDC and Ground terminals are included on the VMX-pi circuit board bottom side, and may be used to power an external fan for cooling system components. The 5VDC on this connector is generated by the onboard 5V regulator for external devices.

### LEDs

LED	Color	Description	Normal State
<b>S1</b>	Green	MPU-9250 Interrupt Status	On
<b>S2</b>	Green	MPU-9250 Communication Status	On
<b>3.3V</b>	Green	Internal Circuitry 3.3V Power Good	On
<b>Fault</b>	Red	External Device Power Fault	Off
<b>CAN Status</b>	Green	CAN Bus Communication Good	On (when actively communicating with CAN bus)
<b>CAL Status</b>	Orange	Calibration in progress	Off (blinks during calibration)

## Buttons

Name	Description
<b>Reset</b>	When pressed, the VMX-pi microcontroller is reset
<b>CAL</b>	<ul style="list-style-type: none"><li>• When held during power-on, places the board into Firmware Update Mode</li><li>• When held down for 5 seconds during operation, schedules Factory &amp; Omnimount Calibration to occur when VMX-pi is next restarted/powered-on</li></ul>



## Physical Dimensions

### Circuit Board Dimensions

